

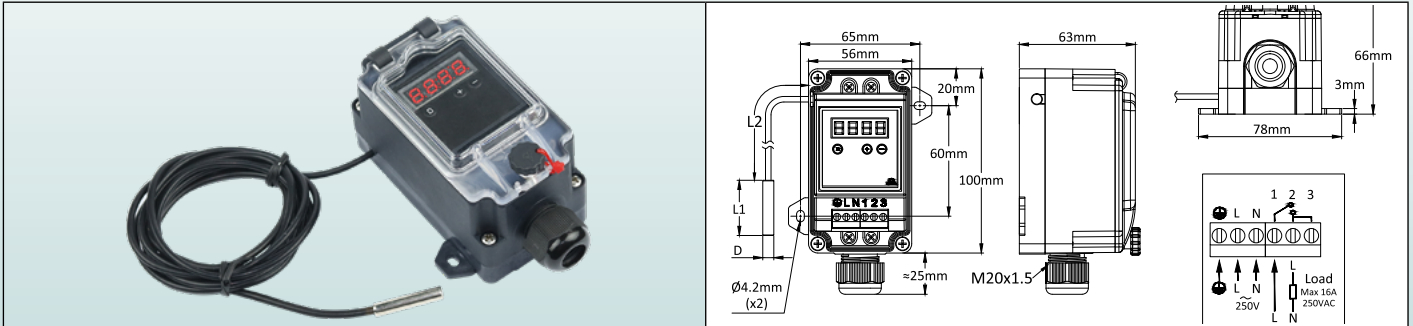

Type: 2DPAP6F



This **ultra-compact** electronic temperature controller was designed to provide the simplest and instinctive end user setting. It can be used by un-trained operators. It provides simple On Off action temperature control.

It is possible to set °C or °F display, heating or cooling relay output, decimal display, sensor type and temperature range by internal Dip switches (Without access by end user).

End user has only access to set point and differential setting.

Adjustment of maximum temperature setting allowed to the operator can be set without the need to open the control.

This control is designed to be wall mounted, in industrial or commercial buildings, or in livestock premises in indoor or outdoor applications.

Main features

Enclosure: 100 × 56 × 66mm. In black PA66, impact resistant (IK10), UV resistant, and has the highest ingress protection level: IP69K (resistant to high pressure hot water washing). Transparent polycarbonate window, with gasket and knurled opening screw with possibility of sealing (5 seals supplied as standard).

Wall mounting by two removable legs, 60 × 65mm between axis.

Display: 3+1 digit LED. The fourth digit is used to display °C or °F, upon setting made.

Set point setting: In normal use, the display shows measured temperature. Push “+” or “-” keys will display the set point value, and at that time it can be adjusted with “+” and “-” keys. No action during 5 seconds will register the new set point value and bring back display to measured value.

Temperature differential setting: In normal use, when the display shows measured temperature, push “D” key will display the differential value, at that time it can be adjusted with “+” and “-” keys. Push “D” again or no action during 5 seconds will register the new differential value and bring back display to measured value.

Action: On-OFF.

Temperature sensor: Pt100 (3 wires) or NTC 10 kilo-ohms @25°C, B= 3380 (2 wires) Temperature sensor can be selected by a dip switch on circuit (No access to final user).

Accuracy: +/-1% of scale.

Temperature adjustment ranges:

- 30+120°C (-20+250°F), with 1° display
- 30.0 to +40.0°C (-20.0 + 99.9°F), with 1/10° display
- 30+400°C (-20+750°F), with 1° display

Temperature range and decimal digit can be selected by dip switches on circuit (No access to final user).

Power supply: 220 to 250V, 50Hz or 60Hz.

Relay output: Single pole, 16A250V res., 100.000 cycles. The digital display provides relay position.

Relay action: Heating or cooling, (relay contact open or close on temperature rise action) can be selected by a dip switch on circuit (No access to final user).

°C or °F display: Can be selected by a dip switch on circuit (No access to final user).

Maximum possible set point adjustment by user: Push “D” button more than 10 seconds, display shows the maximum temperature that can be set by user. Then it is possible to adjust this value with “+” and “-”, push again on “D” or do nothing during 5 seconds will register the maximum possible setting value and control will come back to measured valued.

Ambiant: -20+60°C, 10-90% RH.

Power: <4W.

Safety:

- If there is no power supply to the electronic board, relay output contact will open
- If Pt100 sensor or NTC is broken or not connected properly, relay output contact will open and display will show “EEE”
- If measured temperature is higher than allowed by the set range, display will show HHH
- If measured temperature is lower than -30.0°C or -20.0°F, display will show LLL

Electrical connections:

- Power input for electronic board: Neutral, phase, ground, with 2.5mm² terminals
- Relay input and output: 2.5mm² terminals.
- Temperature sensor: three 2.5mm² screw terminal. Access to these terminals is possible only after removing the internal cover.

Digital display electronic controller, ON-OFF action, IP69K and IK10 enclosure, wall mounting



Internal parameters setting: Process is given on request to approved distributors. This allows to store only one product and set parameters upon end user request.

Connected temperature sensors: These devices are usually supplied with a connected temperature sensor. If the standard sensor model does not suit you, there are many other models in our range. Consult our sales department. On request these boxes can also be delivered without sensor, for use of customer sensors. (Subject to compatibility of the connecting cable diameter).

Compliance with Standards: Comply with LVD, EMC (CE certificate by TÜV) and ROHS

Main references

Heating control						
References	Temperature range	Sensor	Display digit point	Display Unit	Relay Output	Sensor connected
2DPAP6FEB2503F20	-30.0 to +40.0°C	Pt100	88.8	°C	Heating	TSR50030I2000BK6
2DPAP6FAN1503P20	-30+120°C	NTC	888	°C	Heating	TNR60030C20001F
2DPAP6FIB2503F20	-30+400°C	Pt100	888	°C	Heating	TSR50030I2000BK6*
2DPAP6FIB2610G20	-30+400°C	Pt100	888	°C	Heating	TSS40050I2000BK6**
2DPAP6FBN1503P20	-20+250°F	NTC	888	°F	Heating	TNR60030C20001F
2DPAP6FFB2503F20	-20.0 + 99.9°F	Pt100	88.8	°F	Heating	TSR50030I2000BK6
2DPAP6FJB2503F20	-20+750°F	Pt100	888	°F	Heating	TSR50030I2000BK6*
2DPAP6FJB2610G20	-20+750°F	Pt100	888	°F	Heating	TSS40050I2000BK6**
Cooling or fan control						
References	Temperature range	Sensor	Display digit point	Display Unit	Relay Output	Sensor connected
2DPAP6FGB2503F20	-30.0 to +40.0°C	Pt100	88.8	°C	Cooling	TSR50030I2000BK6
2DPAP6FCN1503P20	-30+120°C	NTC	888	°C	Cooling	TNR60030C20001F
2DPAP6FKB2503F20	-30+400°C	Pt100	888	°C	Cooling	TSR50030I2000BK6*
2DPAP6FHB2503F20	-20.0 + 99.9°F	Pt100	88.8	°F	Cooling	TSR50030I2000BK6
2DPAP6FDN1503P20	-20+250°F	NTC	888	°F	Cooling	TNR60030C20001F
2DPAP6FLB2503F20	-20+750°F	Pt100	888	°F	Cooling	TSR50030I2000BK6*
No internal setting made, sold only to approved distributors.						
2DPAP6FO						Without

*: This sensor can be used only up to 200°C (390°F)

** : This sensor can be used up to 400°C (750°F).

Standard temperature sensors

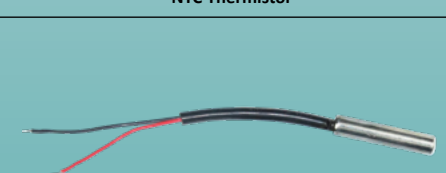
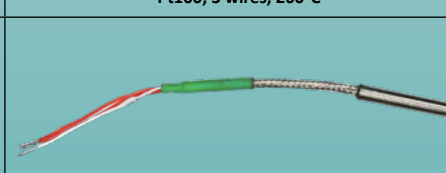
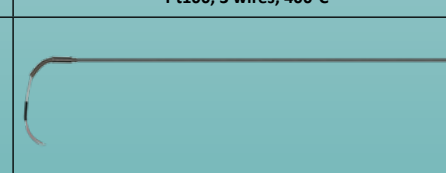
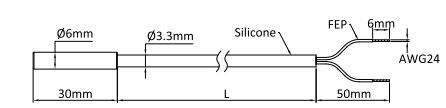
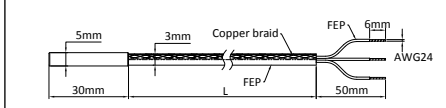
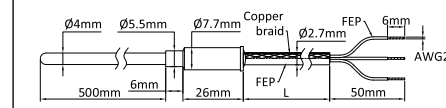
NTC Thermistor	Pt100, 3 wires, 200°C	Pt100, 3 wires, 400°C
		
		
<p>Value: 10Kohms @25°C, B= 3380 Accuracy: +/-1% on R25 e+/-1% on B Temperature range: -20°C+120°C Probe: Nickel plated copper, 6 x 30mm Cable: AWG24, FEP + silicone insulation, dia 3.3mm, length 2m</p>	<p>Accuracy and tolerances: Class B, ±0.3°C @ 0°C. (±0.12 Ω @ 0°C). Temperature range: -50°C, +200°C Probe: Stainless Steel 304, dia. 5mm x 30mm Cable: 3 x AWG24, FEP insulation, + metal braid + FEP, T 200°C, dia. 3mm, length 2m</p>	<p>Accuracy and tolerances: Class B, ±0.3°C @ 0°C. (±0.12 Ω @ 0°C). Probe temperature range: -50°C, +400°C Probe: Stainless Steel 304, dia. 4mm x 500mm Cable: 3 x AWG24, FEP insulation, + metal braid + FEP, T 200°C, dia. 2.7mm, length 2m</p>
Reference: TNR60030C20001F6	Reference: TSR50030I2000BK6	Reference: TSS40050I2000BK6

Because of permanent improvement of our products, drawings, descriptions, features used on these data sheets are for guidance only and can be modified without prior advice